

Design: O/M + Bartenbach GmbH

Recessed luminaire with housing and perforated cover plate made of aluminium with textured-paint finish.

Aluminium end caps.

Easy recessing system with spring clips.

LED CRI>90 / >50.000h, L80/B10 / 3-step MacAdam
340mA power supply included.
IP20 | 230Vac | 50/60Hz

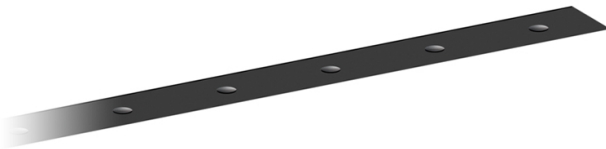

LED	2700K	Light Source	Luminaire
Power	12W		15W
Flux	1000lm		770lm
Efficiency	83lm/W		51lm/W
LOR	-		77%
UGR	-		<13

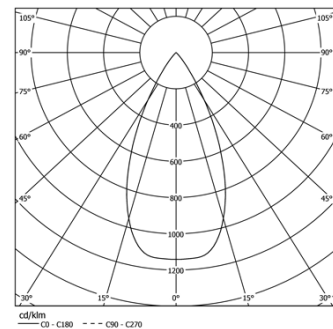

Beam angle
Wide flood 50°

Application



Weight
1,2Kg

mm

26x593

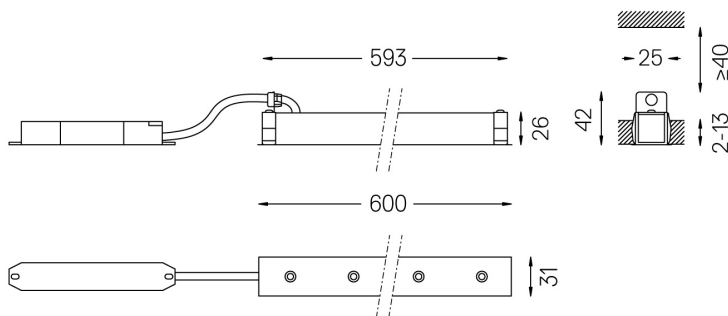

Finishes

- .01 White / RAL 9010
- .02 Black / RAL 9005