

23+45W / 1150+2300lm / 3000K / DALI /
Diffuse Direct/ Indirect / 1485mm

64156



Design: Eduardo Souto de Moura
MGB Pendant Indirect module with housing made of aluminium profile with 25micron maximum corrosion resistance anodization with textured electrostatic 100% polyester paint.

Frosted acrylic diffuser with user friendly clipping system.

Steel end caps with textured electrostatic 100% polyester paint.

Frosted acrylic diffuser for direct light and indirect light.

Fitting accessories supplied separately.

LED CRI>80 / >50.000h, L80/B10 / 3-step MacAdam

Power supply included.

IP20 | 230Vac | 50/60Hz



LED	3000K	Light Source	Luminaire
Power		23+45W	33+65W
Flux		2875+5750lm	1150+2300lm
Efficiency		127lm/W	35lm/W
LOR		-	40%
UGR		-	<25

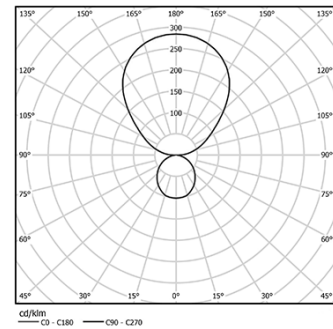

Beam angle
Diffuse Direct/
Indirect

Application



Weight
7Kg

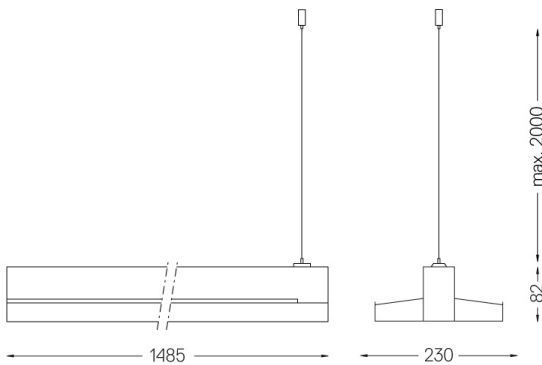

Finishes

- .01 White / RAL 9010
- .02 Black / RAL 9005
- .03 Grey / RAL 9006

Mandatory

56051 Clear base DALI

Ø60x35mm

54081 Aluminium base DALI

Ø60x37mm

For the specific supply of "DALI 2" drivers, please contact:
support@om-light.com